

**650 t All Terrain Crane - 276 ft boom**

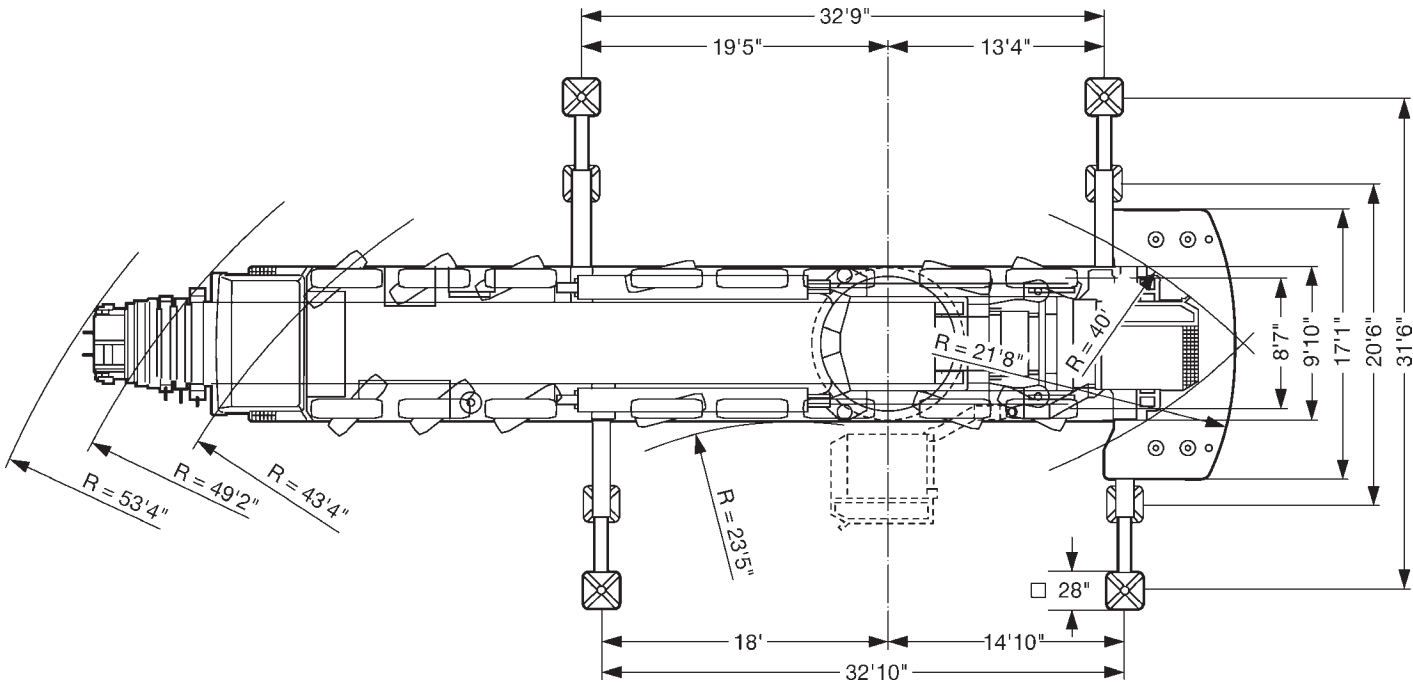
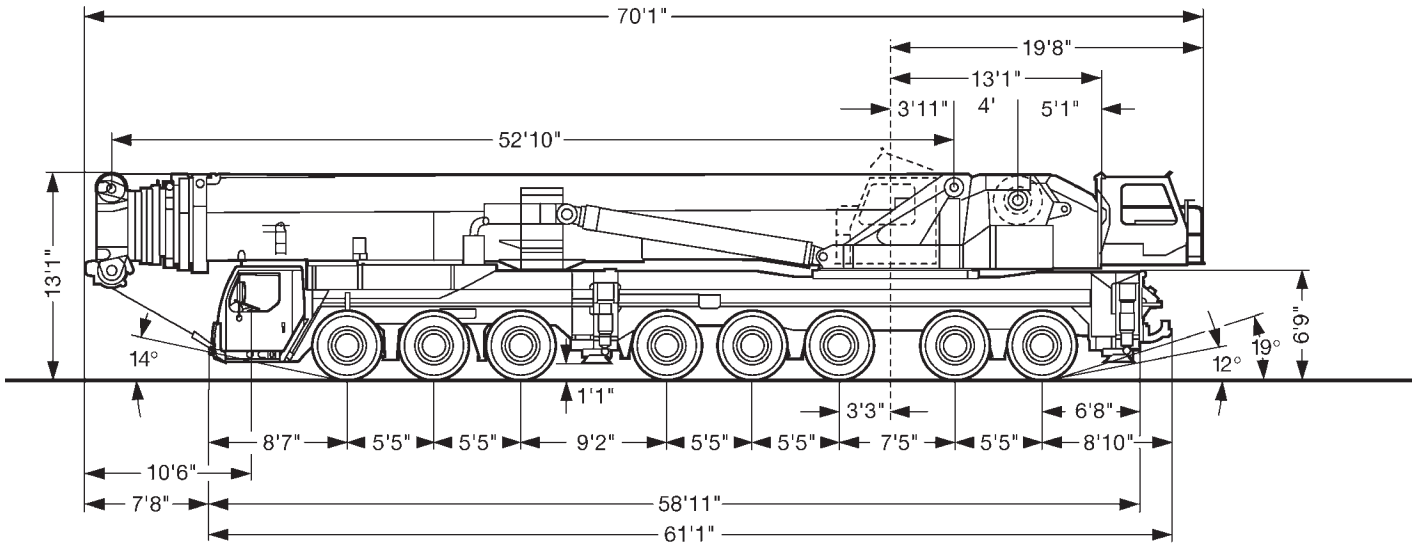

All information given are for reference only.

General Information

Hydraulic Truck Cranes

Crawler Cranes

Carry Decks

Rough Terrain Cranes

Rigging Equipment

Aerial Lifts

Transportation

# 650 t All Terrain Crane

## LIEBHERR LTM 1500 - 276FT



General Information

Hydraulic Truck Cranes

Crawler Cranes

Carry Decks

Rough Terrain Cranes

Rigging Equipment

Aerial Lifts

Transportation

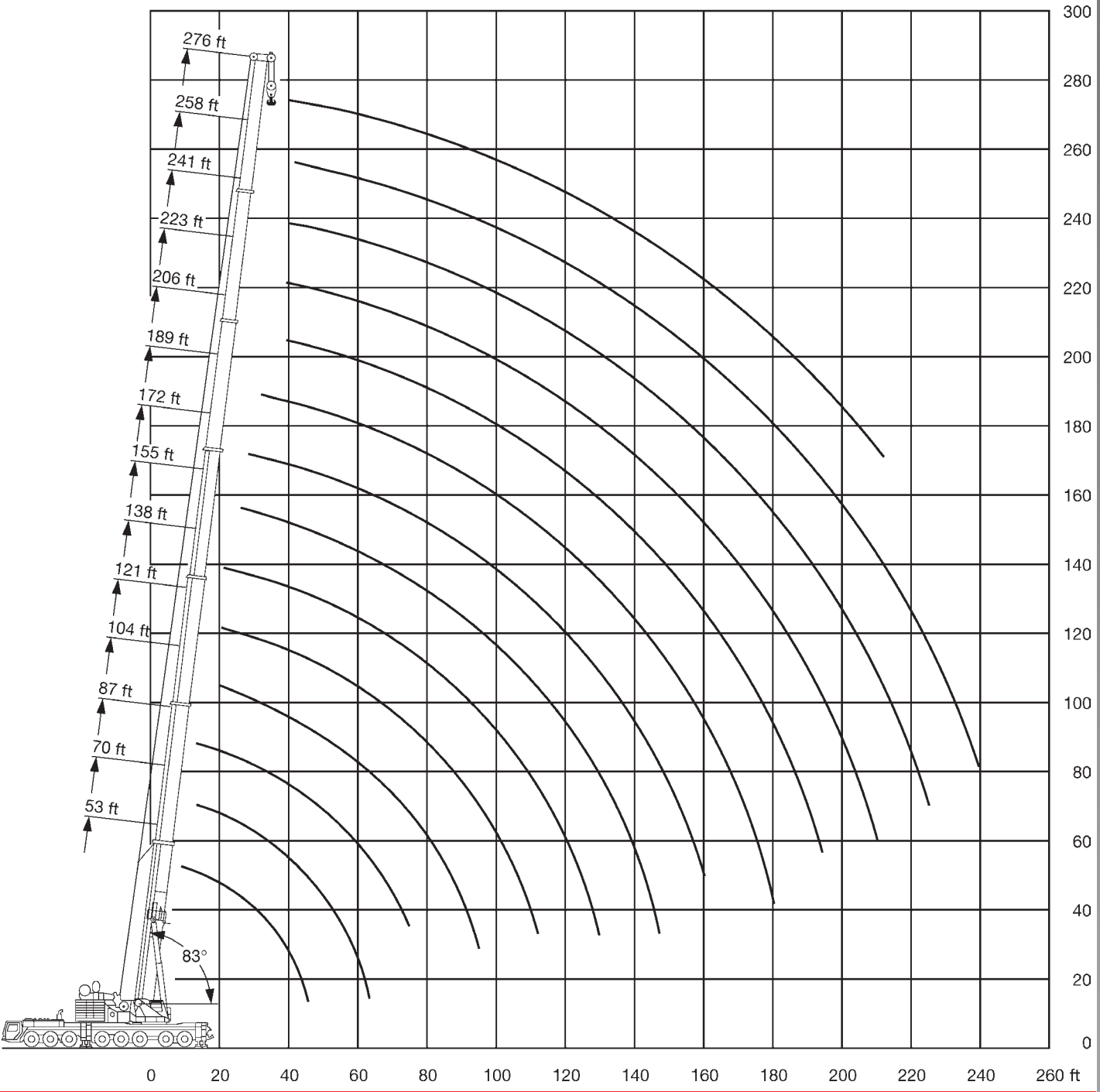

All information given are for reference only.

  
 53-276 ft

  
 297,700 lbs

  
 32'10"x31'6"

  
 360°

**85**  
 85%

All information given are for reference only.

ft	53*	53**	53	70	87	104	121	138	155	172	189	206	223	241	258	276	ft
10	1189	1189	604														10
12	913	913	604	604													12
14	707	707	604	604	590												14
16	633	622	596	592	562												16
17	619	605	581	576	547	437											17
20	553	541	518	513	501	403	349										20
24	485	474	451	446	445	370	315	274									24
28	430	416	397	391	391	338	287	251	217								28
30	406	387	372	367	366	322	274	241	209	176							30
34	365	339	331	325	324	294	252	223	193	165	142						34
38	323	301	296	290	289	269	231	206	179	155	134						38
40	305	283	280	273	273	257	221	198	172	150	130	112	99				40
45	267	248	247	241	240	230	197	179	157	140	121	105	93				45
50				213	212	210	181	162	144	130	113	98.5	87.5	77			50
55				189	188	190	167	146	132	120	106	92	82.5	73	65	49.4	55
65				138	150	152	143	121	110	102	93.5	81	73	65.5	59.1	44.4	65
75					123	125	121	104	93.5	87	82	72	65.5	58.6	53.2	39.5	75
90						94.5	90.5	83.5	77.5	69.5	66.5	59.5	55.6	50	45.8	33.2	90
95						85.5	82.5	78.5	73	65.5	62.5	56.1	52.4	47.2	43.7	31.3	95
100							75	73.5	68.5	62	59.1	52.9	49.2	44.4	41.5	29.5	100
105							68.5	69	64.5	58.3	55.8	49.8	46.2	42	39.5	27.6	105
110							63	65.5	60.5	54.9	52.7	47	43.3	39.8	37.1	25.4	110
115								61.5	56.9	51.7	49.8	44	40.6	37.7	34.9	23.5	115
120								56.9	53	48.6	47	41	38.3	35.6	33	21.8	120
125								52.4	48.8	45.7	44.3	38	36.3	33.7	31.2	20.3	125
130								48.2	44.8	42.9	41.7	35.2	34.4	31.8	29.5	18.8	130
135									41	40.1	39.2	33	32.6	30	27.9	17.4	135
140									37.5	37.4	36.8	31.1	30.6	28.2	26.4	16.1	140
145									24.5	34.9	34.4	29.2	28.6	26.5	24.9	14.8	145
150									22.6	32.4	32.1	27.4	26.7	24.9	23.4	13.5	150
155										29.9	29.9	25.7	24.8	23.3	22	12.3	155
160										22.4	27.8	24.1	23	22	20.6	11.1	160
165											25.7	22.5	21.3	20.9	19.4	10.1	165
170											23.6	20.9	20.1	19.8	18.5	9.4	170
175											21.6	19.4	18.9	18.7	17.7	8.7	175
180											13.7	17.9	17.8	17.6	16.9	8.1	180
185												16.5	16.6	16.5	16.1	7.5	185
190												15.1	15.5	15.5	15.4	6.9	190
195												13.5	14.5	14.5	14.6	6.3	195
200													13.4	13.5	13.7	5.8	200
205													12.4	12.6	12.9	5.2	205
210													8.5	11.7	12.1	4.7	210
215													7.9	10.7	11.2	4.3	215
220														9.8	10.4		220
225														9	9.7		225
230															8.9		230
235															8.2		235
240															7.5		240

\* over rear, 363,800 lbs counterweight

\*\* over rear

General Information

Hydraulic Truck Cranes

Crawler Cranes

Carry Decks

Rough Terrain Cranes

Rigging Equipment

Aerial Lifts

Transportation

# 650 t All Terrain Crane

## LIEBHERR LTM 1500 - 276FT



General Information

Hydraulic Truck Cranes

Crawler Cranes

Carry Decks

Rough Terrain Cranes

Rigging Equipment

Aerial Lifts

Transportation

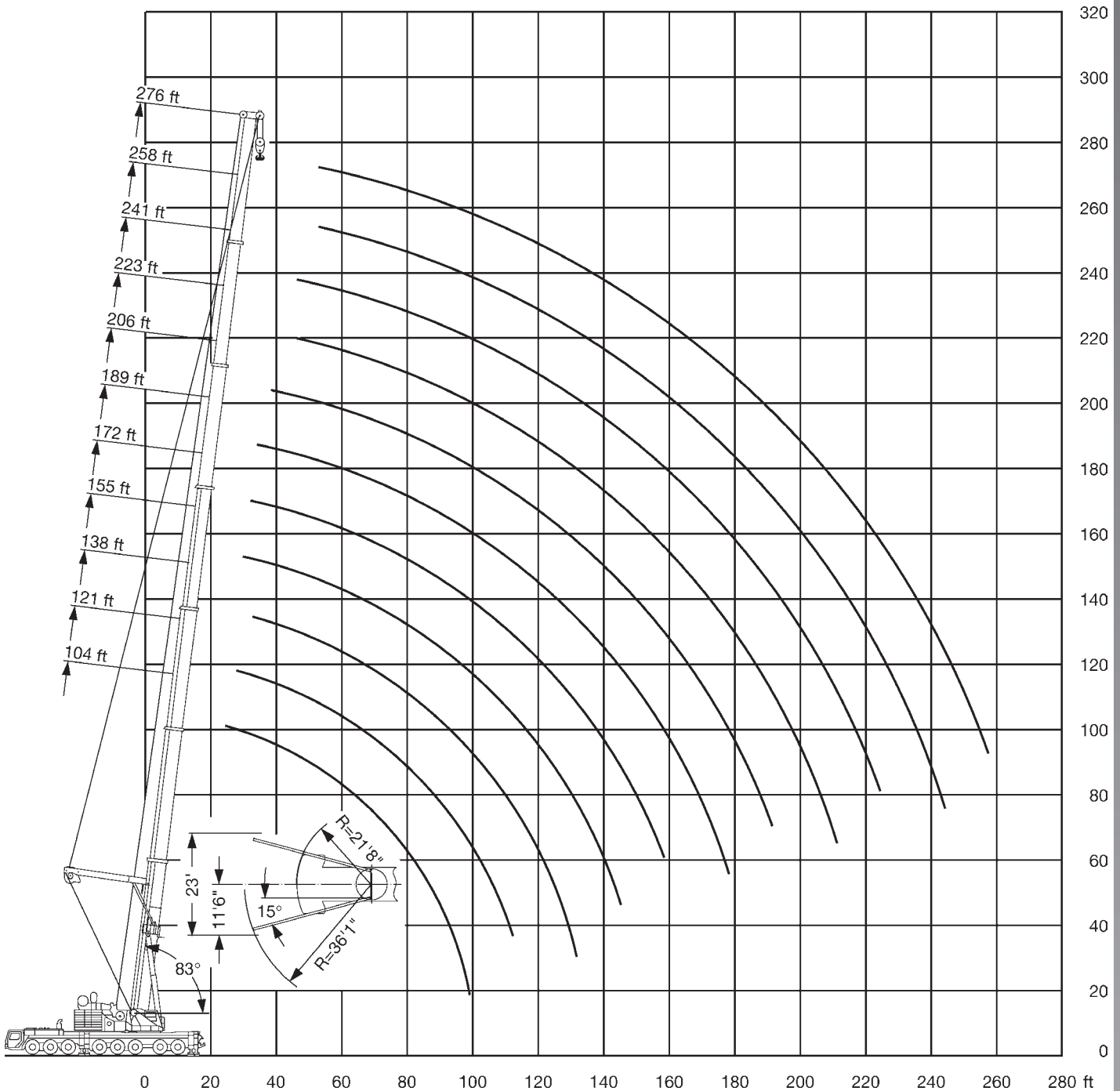

All information given are for reference only.

  
 104-276 ft

  
 363,800 lbs

  
 32'10"x31'6"

  
 360°

**85**  
 85%

All information given are for reference only.

ft	104	121	138	155	172	189	206	223	241	258	276	ft
17	414											17
20	402	431										20
24	389	405	359									24
28	375	365	336	314								28
30	365	346	322	300	266							30
34	331	314	295	278	253	232						34
38	300	287	270	260	240	221						38
40	286	273	259	252	235	215	195	147				40
45	255	245	236	231	217	198	184	140				45
50	227	221	215	213	201	186	172	153	127			50
55	203	201	195	198	187	177	161	146	121	103	73	55
60	182	185	178	184	175	167	150	140	116	98.5	70	60
65	164	168	163	171	164	157	141	134	112	95	67	65
70	150	152	153	158	155	149	134	127	108	91.5	64.5	70
75	136	139	145	149	145	141	129	120	104	88	62	75
80	123	131	137	140	134	133	123	114	100	85.5	59.8	80
85	112	124	130	129	125	126	117	108	97	82.5	57.8	85
90	98	119	122	120	119	117	111	103	93.5	79.5	55.8	90
95	90.5	113	114	111	112	109	105	98	90.5	77	53.8	95
100		105	106	105	105	102	100	93	87.5	74.5	52	100
105		95	98.5	100	98	97	95.5	88.5	85	72.5	50.2	105
110		82	92	94.5	91.5	92.5	89.5	85.5	82	70	48.6	110
115			85	89.5	86	88	83.5	83	77.5	68	47.1	115
120			77	84	80.5	83	78	79.5	72.5	66	45.6	120
125			67	78.5	75	78	73	75.5	68.5	64	44.2	125
130			57.5	74	70.5	73	68.5	71	64	62.5	42.8	130
135				66.5	66.5	69	64	66.5	60.5	60.5	41.5	135
140				58.9	62.5	65	60	62.5	56.6	58.1	40.3	140
145				50.8	58.3	61	56.3	59	52.9	54.8	39.1	145
150				38.9	52.2	57.7	52.9	55.5	49.4	51.7	37.9	150
155					46	54.5	49.7	52.3	46.2	48.6	36.8	155
160					39.8	50.7	46.7	49.3	43.2	45.6	35.7	160
165						46.1	43.8	46.4	40.3	42.7	34.6	165
170						40.8	41.2	43.7	37.7	40.1	33.6	170
175						35.8	37.8	41.2	35.2	37.6	32.7	175
180						30.3	33.8	38.9	32.8	35.2	31.7	180
185							29.4	36.5	30.6	32.9	30.8	185
190							25	33.9	28.4	30.8	29.9	190
195							20.9	30	26.4	28.8	28.9	195
200								26.2	24.5	26.9	27.3	200
205								22.5	22.3	25.1	25.5	205
210									19.2	23.3	23.8	210
220									12.7	19.5	20.5	220
230										14	17.6	230
240										8.3	14	240
245											11.6	245
250											9.2	250
255											6.9	255

General Information

Hydraulic Truck Cranes

Crawler Cranes

Carry Decks

Rough Terrain Cranes

Rigging Equipment

Aerial Lifts

Transportation

# 650 t All Terrain Crane

## LIEBHERR LTM 1500 - 276FT



104-276 ft



297,700 lbs



32'10"x31'6"



360°

**85**

85%

General Information

Hydraulic Truck Cranes

Crawler Cranes

Carry Decks

Rough Terrain Cranes

Rigging Equipment

Aerial Lifts

Transportation

ft	104	121	138	155	172	189	206	223	241	258	276	ft
17	414											17
20	402	431										20
24	389	405	359									24
28	375	365	336	314								28
30	365	346	322	300	266							30
34	329	314	295	278	253	232						34
38	292	287	270	260	240	221						38
40	275	273	259	252	235	215	195	147				40
45	242	239	236	231	217	198	184	140				45
50	214	215	212	213	201	186	172	153	127			50
55	189	193	189	195	187	177	161	146	121	103	73	55
60	170	172	176	177	174	167	150	140	116	98.5	70	60
65	152	155	163	167	159	157	141	134	112	95	67	65
70	137	146	151	153	149	145	134	127	108	91.5	64.5	70
75	123	138	143	140	140	134	129	120	104	88	62	75
80	111	130	131	129	130	125	122	113	100	85.5	59.8	80
85	101	121	120	123	120	117	114	105	97	82.5	57.8	85
90	98	112	111	114	111	112	106	99	93.5	79.5	55.8	90
95	90.5	104	103	106	102	105	98.5	95.5	89.5	77	53.8	95
100		96	95	98.5	94.5	97.5	91.5	91.5	84	74.5	52	100
105		89	88.5	91.5	88	90.5	85.5	86.5	78	72.5	50.2	105
110		81	82.5	85.5	82	84.5	79.5	81	73	70	48.6	110
115			76.5	80	76.5	79	74	76.5	68	68	47.1	115
120			71.5	74.5	71	73.5	68.5	71.5	63.5	64.5	45.6	120
125			66.5	70	66.5	69	64	66.5	59.4	60.5	44.2	125
130			57.4	65.5	62	64.5	59.6	62.5	55.5	56.9	42.8	130
135				61.5	57.9	60.5	55.5	58.3	51.9	53.4	41.5	135
140				56.9	54.1	56.7	51.8	54.5	48.3	50	40.3	140
145				50.8	50.6	53.2	48.3	51	44.8	46.9	39.1	145
150				38.9	47.4	50	45	47.7	41.6	44	37.9	150
155					44.4	47	42	44.7	38.6	41	36.8	155
160					39.8	44.2	39.2	41.9	35.7	38.2	35.7	160
165						41.5	36.6	39.2	33	35.5	34.6	165
170						39.1	34.1	36.7	30.8	33	33.3	170
175						35.3	31.8	34.4	28.2	30.7	31.1	175
180						30.3	29.6	32.2	26	28.4	28.9	180
185							27.4	30.1	23.9	26.4	26.8	185
190							24.9	28.1	22	24.4	24.8	190
195							20.9	26.2	20.1	22.5	23	195
200								24.5	18.4	20.7	21.2	200
205								22.2	16.7	19	19.5	205
210									15.1	17.4	17.9	210
220									11.8	14.5	14.9	220
230										11.8	12.2	230
240										8.3	10.2	240
250											8.1	250
255											6.7	255

All information given are for reference only.

All information given are for reference only.

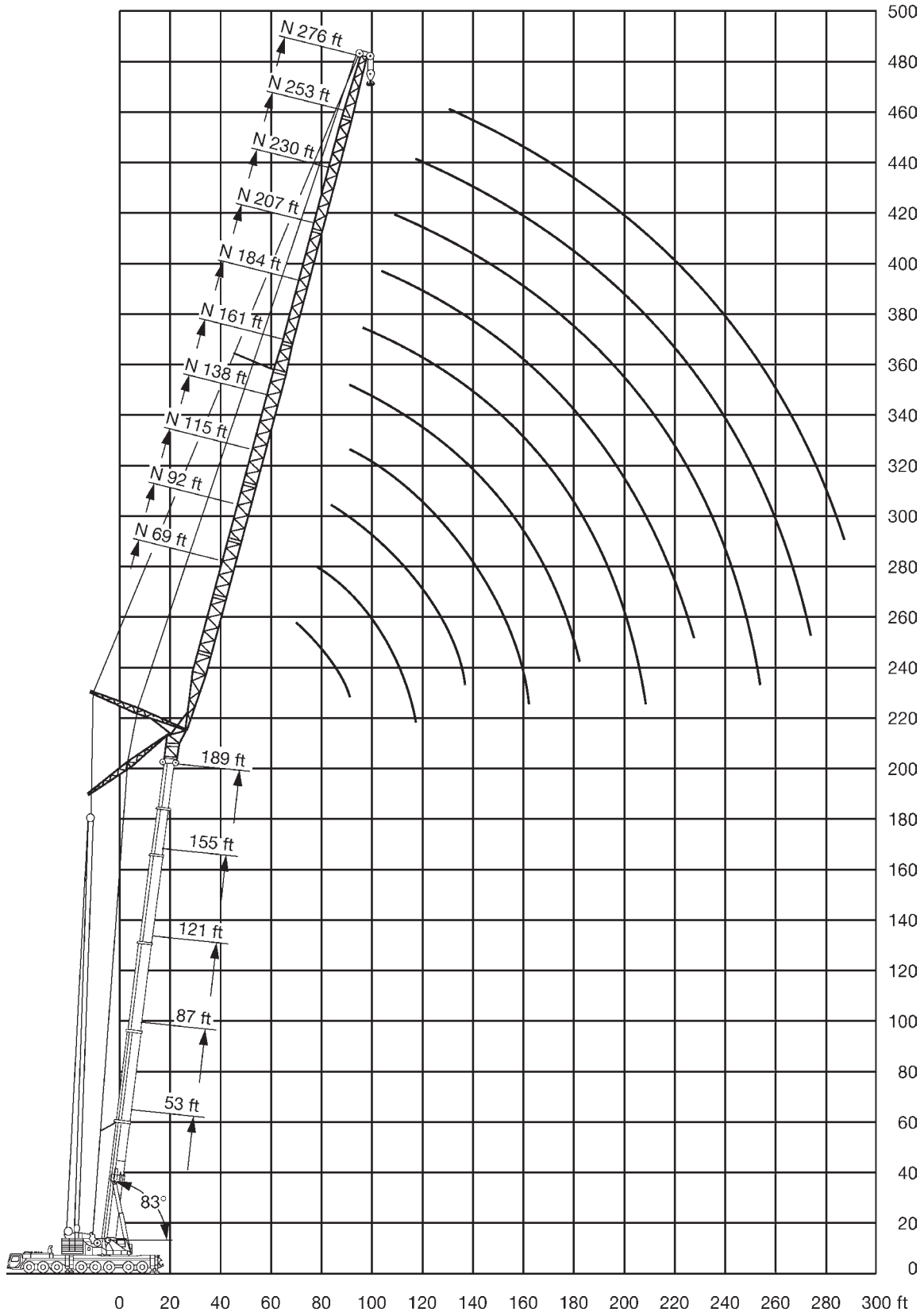

General Information  
 Hydraulic Truck Cranes  
 Crawler Cranes  
 Carry Decks  
 Rough Terrain Cranes  
 Rigging Equipment  
 Aerial Lifts  
 Transportation

# 650 t All Terrain Crane

LIEBHERR LTM 1500 - 276FT



General Information



53 ft  
83°



69-299 ft



297,700 lbs



32'10"x31'6"



360°

**85**

85%

Hydraulic Truck Cranes

Crawler Cranes

Carry Decks

Rough Terrain Cranes

Rigging Equipment

Aerial Lifts

Transportation

ft	69	92	115	138	161	53* 184	207	230	253	276	299	ft
40	173											40
45	159											45
55	139	132	128									55
60	133	124	119	116								60
65	128	116	112	108								65
75	128	114	101	96.5	92	85.5						75
80		114	96	92	87	81.5	74.5					80
85		114	94	88	82.5	77.5	71					85
95		114	92.5	81.5	75.5	71	65.5	59.3	54			95
100			91.5	79.5	72.5	68.5	63	57.1	52.2	42.6		100
110			90	79	68.5	63	58.4	53.1	48.7	41.4		110
115			90	79	68	60.5	56.2	51.3	47.1	40.2	35.2	115
120			84.5	79	68	58.4	54	49.5	45.6	39.1	34.3	120
125				79	68	57	52	47.8	44.1	38	33.4	125
130				79	68	56.4	50.1	46.3	42.8	36.9	32.6	130
135				77.5	68	55.9	48.8	44.7	41.5	35.9	31.7	135
140				71.5	68	55.3	48	43.3	40.2	35	30.8	140
150					68	54.3	47.5	40.5	37.9	33.4	29.2	150
160					60.5	53.4	47	38.5	35.7	31.9	27.8	160
165					52.5	53	46.8	37.9	34.7	31.2	27.1	165
170					44	53	46.5	37.3	33.8	30.6	26.4	170
175						52.9	46.3	36.7	33.5	29.9	25.8	175
180						49.6	46	36.1	33.3	29.2	25.2	180
185						43.8	45.8	35.7	33.1	28.5	24.6	185
190						38.2	45.6	35.4	32.9	27.8	24	190
195							45.4	35.4	32.7	27.5	23.4	195
200							42	35.4	32.5	27.2	23.2	200
205							37	35.4	32.3	26.8	23.2	205
210							32	35.4	32.1	26.4	23.2	210
215							27.3	35.4	32	26	23.2	215
220								34.3	31.8	25.6	23	220
225								31.8	31.7	25.2	22.8	225
230								27.6	31.7	24.8	22.5	230
235								23.6	31.7	24.5	22.2	235
240									29.5	24.1	21.9	240
245									26.5	23.7	21.6	245
250									23.1	23.4	21.3	250
255									19.9	23	21.1	255
260									16.8	22.7	20.8	260
265										22.3	20.5	265
270										21.2	20.3	270
275										18	20	275
280										14.9	19.8	280
290											16.6	290
300											11.7	300
305											9.4	305

\* + 13 ft adapter

All information given are for reference only.





All information given are for reference only.

ft	69	92	115	138	161	87* 184	207	230	253	276	299	ft
50	170											50
55	160	152										55
60	156	142	135									60
70	153	128	122	113								70
75	151	124	116	109	98							75
80		122	110	104	94.5	83.5						80
90		117	104	96.5	88	78.5	69					90
95		116	103	93	85.5	76.5	67	58.2				95
100		113	102	90	82.5	74	65.5	57	49.4			100
105			101	89	80	72	64	55.8	48.5	41		105
115			95	88	75.5	68.5	61	53.6	46.9	38.9	33.3	115
120			90.5	87	74	67	59.4	52.6	46.1	37.9	32.7	120
125				85	74	65	58	51.5	45.4	37	32	125
130				81	73.5	63.5	56.6	50.3	44.7	36.1	31.3	130
135				77.5	73	62	55.2	49.1	43.8	35.2	30.6	135
140				74.5	72	61.5	53.9	48	43	34.4	30	140
150				64	66.5	61.5	52.2	45.9	41.2	32.8	28.8	150
160					61.5	60	52.1	44.1	39.7	31.4	27.6	160
165					59	57.8	52.1	43.5	38.9	30.8	27.1	165
170					56.8	55.6	52.1	42.8	38.1	30.1	26.6	170
175						53.5	51.6	42.2	37.4	29.5	26.1	175
180						51.6	50.3	41.6	37.1	28.9	25.6	180
185						49.6	48.4	41	37	28.3	25.2	185
190						47.4	46.6	40.4	37	27.9	24.8	190
195						41.1	45	39.8	37	27.4	24.4	195
200							43.4	39.3	37	27.1	24.1	200
205							41.9	38.7	36.9	26.7	23.8	205
210							40.5	38.2	36.6	26.3	23.5	210
215							36.9	37.7	36	26	23.2	215
220								36.7	35	25.7	22.9	220
225								35.4	33.7	25.3	22.6	225
230								34.1	32.6	25	22.4	230
235								30.7	31.4	24.6	22.1	235
240								26.4	30.3	24.3	21.8	240
245									29.3	23.9	21.5	245
250									28.3	23.6	21.2	250
255									27.4	23.3	21	255
260									24.5	23	20.7	260
265										22.7	20.5	265
270										22.4	20.2	270
275										22.1	20	275
280										20.9	19.7	280
285										17.9	19.2	285
290											18.5	290
300											16.6	300
305											14.5	305

\* + 13 ft adapter

# 650 t All Terrain Crane

LIEBHERR LTM 1500 - 276FT



General Information



121 ft  
83°



69-299 ft



297,700 lbs



32'10"x31'6"



360°

**85**

85%

Hydraulic Truck Cranes

Crawler Cranes

Carry Decks

Rough Terrain Cranes

Rigging Equipment

Aerial Lifts

Transportation

ft	69	92	115	138	161	121* 184	207	230	253	276	299	ft
55	158											55
60	148	140										60
70	134	125	117									70
75	129	119	112	100								75
80	123	113	107	98	85.5							80
90		105	98	92	82.5	70						90
95		101	95	88.5	80.5	69	58.3					95
100		97.5	92	85.5	78.5	67.5	57.6	48.4				100
105			89.5	82.5	76	66	56.9	47.8	40.9			105
115			85	77.5	71.5	63.5	55.4	46.8	39.9	33.7		115
120			82.5	75.5	69.5	62	54.5	46.3	39.5	33.3	27	120
125			80.5	73.5	67.5	60.5	53.5	45.8	39.1	32.9	26.7	125
130			77	72	66	59.1	52.6	45.1	38.6	32.6	26.5	130
135				70.5	64.5	57.6	51.7	44.4	38.2	32.2	26.2	135
140				68.5	63	56.2	50.7	43.7	37.8	31.9	25.9	140
150				63.5	60	53.7	48.5	42.5	36.9	31	25.5	150
155					58.7	52.5	47.5	41.8	36.5	30.4	25.3	155
160					56.9	51.4	46.5	41	36.1	29.9	25.1	160
165					54.8	50.3	45.6	40.1	35.7	29.4	25	165
170					52.7	49.3	44.7	39.3	35.3	28.9	24.8	170
175					50.7	48.3	43.8	38.5	34.9	28.4	24.6	175
180						46.9	42.9	37.8	34.3	27.9	24.3	180
185						45.4	42.1	37.2	33.6	27.4	24	185
190						43.7	41.3	36.5	33	27	23.7	190
195						42.2	40.5	35.9	32.3	26.5	23.4	195
200							39.5	35.3	31.7	26.1	23.1	200
205							38.3	34.7	31.1	25.8	22.8	205
210							36.9	34.1	30.5	25.5	22.5	210
215							35.6	33.6	29.9	25.2	22.3	215
220							34.5	32.7	29.4	24.9	22	220
225								31.7	28.8	24.6	21.8	225
230								30.6	28.3	24.4	21.6	230
235								29.5	27.5	24.1	21.3	235
240								28.5	26.5	23.9	21.1	240
245									25.6	23.5	20.7	245
250									24.6	22.9	20.3	250
255									23.7	22	19.9	255
260									22.9	21.1	19.5	260
265									22.1	20.3	19	265
270										19.5	18.2	270
280										18	16.6	280
285										17.3	15.8	285
290											15.1	290
300											13.6	300
305											13	305
310											12.4	310

\* + 13 ft adapter

All information given are for reference only.



All information given are for reference only.

ft	69	92	115	138	161	155*	184	207	230	253	276	299	ft
60	105												60
65	99.5												65
70	95	86.5											70
75	91.5	83	75.5										75
80	88	79.5	73	65									80
90	82	74	68	61.5	53.9								90
95		71	65.5	59.3	52.6	45.4							95
100		69	63	57.4	51.3	44.3	38.1						100
105		66.5	61.5	55.6	49.7	43.3	37.2	31.3					105
110		64.5	59.6	53.9	48.3	42.2	36.3	30.6					110
115			58	52.4	46.9	41	35.5	29.9	26.1				115
120			56.4	51.1	45.6	39.9	34.7	29.2	25.5	21.7			120
125			54.9	49.8	44.3	38.7	33.8	28.6	24.9	21.2	16.4		125
130			53.4	48.6	43.1	37.7	32.8	28	24.4	20.7	16		130
135			52	47.5	42.2	36.7	31.9	27.3	23.8	20.2	15.6		135
140				46.4	41.3	35.7	30.9	26.5	23.2	19.7	15.3		140
150				44.3	39.7	34.1	29.3	25	22	18.8	14.5		150
155				43.3	38.9	33.4	28.4	24.3	21.4	18.3	14.2		155
160					38.1	32.8	27.7	23.6	20.9	17.8	13.8		160
170					36.7	31.5	26.6	22.3	19.8	16.8	13.1		170
175					36	31	26.2	21.7	19.2	16.4	12.7		175
180					35.4	30.4	25.7	21.1	18.7	15.9	12.3		180
185						29.8	25.2	20.6	18.3	15.4	12		185
190						29.3	24.8	20.1	17.8	15	11.6		190
195						28.8	24.4	19.7	17.4	14.6	11.3		195
200						28.3	24	19.2	17.1	14.2	11.1		200
205							23.6	18.7	16.7	13.9	10.9		205
210							23.2	18.3	16.4	13.6	10.7		210
215							22.8	17.9	16.1	13.4	10.4		215
220							22.4	17.4	15.8	13.1	10.2		220
225							22	17	15.5	12.9	10		225
230								16.6	15.2	12.6	9.8		230
235								16.2	14.9	12.4	9.6		235
240								15.8	14.6	12.2	9.5		240
245								15.4	14.3	12	9.3		245
250									14	11.8	9.1		250
255									13.8	11.6	8.9		255
260									13.5	11.3	8.8		260
270									13	10.9	8.4		270
275									12.7	10.8	8.3		275
280										10.6	8.1		280
290										10.2	7.8		290
300											7.5		300
310											7.2		310
315											7.1		315
320											6.9		320

\* + 13 ft adapter

General Information

Hydraulic Truck Cranes

Crawler Cranes

Carry Decks

Rough Terrain Cranes

Rigging Equipment

Aerial Lifts

Transportation

# 650 t All Terrain Crane

LIEBHERR LTM 1500 - 276FT



General Information



189 ft  
83°



69-276 ft



297,700 lbs



32'10" x 31'6"



360°

**85**

85%

Hydraulic Truck Cranes

Crawler Cranes

Carry Decks

Rough Terrain Cranes

Rigging Equipment

Aerial Lifts

Transportation

ft	189*										ft
	69	92	115	138	161	184	207	230	253	276	
70	68										70
75	64.5	58.1									75
80	61	55.9	50.4								80
90	56.2	51	46.9	41.6							90
95		48.9	45.1	40.2	34.8						95
100		47	43.3	39	33.7	28.5					100
105		45.5	41.5	37.7	32.6	27.6	23				105
110		44.1	40	36.2	31.6	26.8	22.2				110
115		42.7	38.6	34.9	30.6	25.9	21.5	17.1			115
120			37.3	33.6	29.5	24.8	20.7	16.4	13.2		120
125			36.2	32.3	28.4	23.9	19.7	15.8	12.8		125
130			35	31.2	27.3	22.9	18.7	15	12.3		130
135			34	30.2	26.3	22	17.9	14.3	11.9	9.4	135
140				29.3	25.3	21.2	17	13.6	11.4	9.1	140
145				28.4	24.5	20.3	16.2	12.9	10.9	8.8	145
150				27.5	23.8	19.6	15.4	12.4	10.5	8.5	150
155				26.7	23.1	18.8	14.6	11.9	10.1	8.2	155
160				25.9	22.4	18.1	13.9	11.3	9.6	7.8	160
165					21.7	17.5	13.2	10.8	9.2	7.5	165
170					21.1	16.9	12.5	10.3	8.8	7.1	170
175					20.5	16.3	12.1	9.9	8.4	6.8	175
180					19.9	15.8	11.8	9.4	8	6.4	180
185						15.2	11.5	9	7.6	6.1	185
190						14.7	11.2	8.6	7.3	5.8	190
195						14.2	11	8.3	6.9	5.5	195
200						13.7	10.7	8.1	6.5	5.1	200
205						13.3	10.4	7.8	6.3	4.9	205
210							10.2	7.6	6.1	4.6	210
215							10	7.4	5.9	4.3	215
220							9.8	7.2	5.7	4	220
225							9.5	7	5.5	3.8	225
230								6.7	5.4	3.7	230
235								6.5	5.2	3.6	235
240								6.3	5	3.5	240
245								6.1	4.9	3.4	245
250								5.9	4.7	3.3	250
255								5.8	4.6	3.1	255
260									4.4	3	260
265									4.3	2.9	265
270									4.1	2.8	270
275									4	2.7	275
280										2.6	280
285										2.5	285
290										2.4	290
295										2.3	295
300										2.2	300

\* + 13 ft adapter

All information given are for reference only.

  
223-258 ft  
83°

  
69-230 ft

  
297,700 lbs

  
32'10"x31'6"

  
360°

**85**  
85%

General Information

Hydraulic Truck Cranes

Crawler Cranes

Carry Decks

Rough Terrain Cranes

Rigging Equipment

Aerial Lifts

Transportation

All information given are for reference only.

ft	223*								258*						ft
	69	92	115	138	161	184	207	230	69	92	115	138	161	184	
75	44.3														75
80	42.4	36.7							24.8						80
85	40.3	35.3							23.6						85
90	38.5	33.8	29.7						22.4	17.4					90
95	36.8	32.2	28.6	24.1					21.2	16.3	12.9				95
100		30.6	27.4	23.1	18.8					15.3	12.1	9.6			100
105		29.2	26.1	22.1	17.9	13.1				14.2	11.4	9.1	6.5		105
110		28	24.9	21.1	17.2	12.5				13.5	10.9	8.6	6.1		110
115		26.9	23.7	20.1	16.3	11.8	8.9			12.8	10.3	8.2	5.7	3.2	115
120			22.6	19.1	15.5	11.2	8.5	5.7		12.2	9.9	7.7	5.4	2.9	120
125			21.7	18.2	14.6	10.6	8	5.4			9.4	7.3	5	2.7	125
130			20.8	17.4	13.8	10.1	7.5	5.1			9	6.9	4.6	2.5	130
135			20.1	16.6	13	9.6	7.1	4.8			8.6	6.5	4.3	2.2	135
140			19.3	15.9	12.3	9.1	6.7	4.4			8.3	6.2	3.9		140
145				15.2	11.6	8.7	6.2	4				5.9	3.6		145
150				14.6	10.9	8.2	5.9	3.6				5.6	3.3		150
155				14.1	10.6	7.8	5.5	3.2				5.3	3		155
160				13.5	10.3	7.4	5.1	2.9				5	2.8		160
165					10	7	4.7	2.6				4.8	2.6		165
170					9.7	6.8	4.4	2.4				4.6	2.4		170
175					9.5	6.5	4.1						2.2		175
180					9.2	6.3	3.7								180
185					9	6	3.5								185
190					8.7	5.8	3.3								190
195						5.6	3.2								195
200						5.4	3								200
205						5.2	2.9								205
210							2.7								210
215							2.6								215
220							2.4								220
225							2.3								225

\* + 13 ft adapter

General Information

Hydraulic Truck Cranes

Crawler Cranes

Carry Decks

Rough Terrain Cranes

Rigging Equipment

Aerial Lifts

Transportation

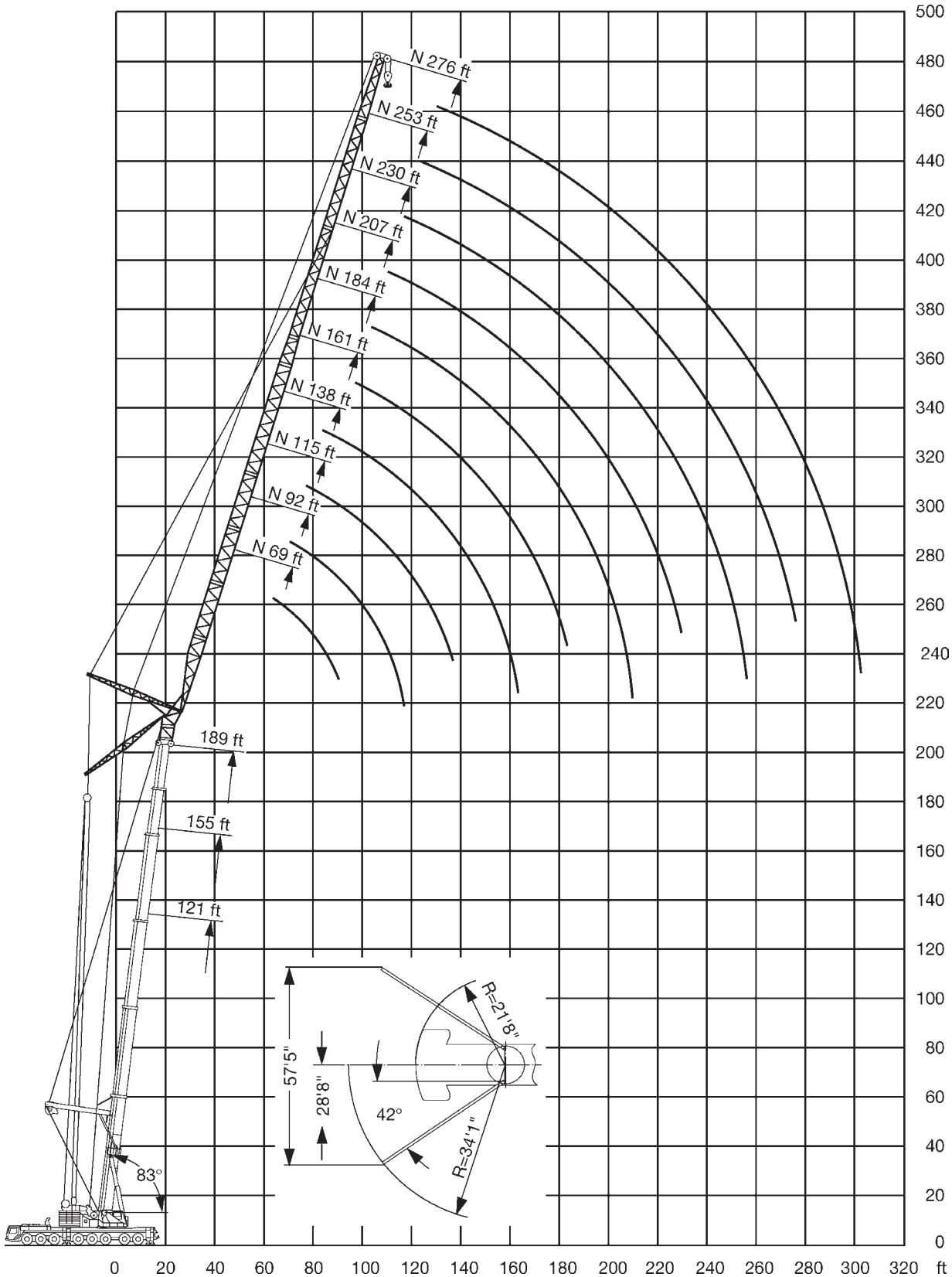

All information given are for reference only.

  
 121 ft  
83°

  
 69-299 ft

  
 363,800 lbs

  
 32'10"x31'6"

  
 360°

**85**

 85%

All information given are for reference only.

ft	69	92	115	138	161	121* 184	207	230	253	276	299	ft
55	195											55
60	184	178										60
70	164	160	157									70
75	154	151	149	138								75
80	144	142	140	135	113							80
90		125	124	122	110	88.5						90
95		118	116	115	108	87.5	72.5					95
100		112	110	109	106	86	72	58.8				100
105			104	103	102	85	71	57.6	49.5			105
110			98.5	97.5	96	84	70.5	56.2	49.1			110
120			89	88	87	82	69.5	53.7	48	37.8		120
125			85	84	82.5	80.5	69	52.5	47.5	37	32.2	125
130			81	80	79	77.5	68.5	51.3	46.9	36.2	32	130
140				73.5	72	71	67.5	49.1	45.3	34.6	30.7	140
145				70	69	68	66.5	48	44.6	33.9	30.1	145
150				67.5	66	65	64	46.9	43.9	33.2	29.5	150
155					63.5	62.5	61.5	45.9	43.2	32.5	28.9	155
160					61	60	58.8	44.9	42.5	31.9	28.3	160
165					58.6	57.7	56.5	44	41.9	31.2	27.8	165
170					56.4	55.5	54.3	43.3	41.2	30.6	27.3	170
175					54.4	53.4	52.2	42.6	40.5	30	26.7	175
180						51.5	50.3	41.9	39.9	29.4	26.2	180
185						49.6	48.5	41.2	39.4	28.8	25.7	185
190						47.9	46.7	40.5	38.8	28.2	25.3	190
195						46.2	45.1	39.9	38.3	27.7	24.8	195
200							43.5	39.3	37.8	27.3	24.3	200
205							42	38.7	37.3	26.8	23.9	205
210							40.6	38.1	36.8	26.4	23.5	210
215							39.3	37.7	36.3	26	23.2	215
220							36.9	36.9	35.6	25.6	22.8	220
225								36	34.5	25.1	22.5	225
230								34.8	33.4	24.8	22.3	230
235								33.7	32.2	24.4	21.9	235
240								31.7	31.2	24	21.7	240
245									30.1	23.7	21.4	245
250									29.2	23.3	21.1	250
255									28.2	23	20.9	255
260									27.3	22.7	20.6	260
265									25.5	22.5	20.3	265
270										22.3	20.1	270
280										22	19.7	280
285										21.3	19.5	285
290											19.4	290
300											18.8	300
305											18.2	305
310											16.8	310

\* + 13 ft adapter

# 650 t All Terrain Crane

LIEBHERR LTM 1500 - 276FT



General Information



155 ft  
83°



69-299 ft



363,800 lbs



32'10" x 31'6"



360°

**85**

85%

Hydraulic Truck Cranes

Crawler Cranes

Carry Decks

Rough Terrain Cranes

Rigging Equipment

Aerial Lifts

Transportation

ft	69	92	115	138	161	155*	184	207	230	253	276	299	ft
60	173												60
70	153	148											70
75	145	141	130										75
80	137	134	125	113									80
90	121	119	116	107	95								90
95		112	110	104	93	76.5							95
100		106	104	101	90.5	76.5	61.5						100
110		94.5	93	92	86.5	76	61.5						110
115			88.5	87.5	84	75	61.5	49.1					115
120			84	83	81	74	61.5	49.1	39.6				120
130			76.5	75.5	73.5	71.5	61	49.1	39.6	31.5			130
135			73	72	70.5	69	60.5	48.5	39.6	31.5	23.9		135
140				69	67	66	60	47.7	39.6	31.5	23.9		140
150				63.5	61.5	60.5	58.7	45.8	39.6	31.1	23.9		150
155				60.5	59.1	58.1	56.7	44.9	39.6	30.6	23.9		155
160					56.7	55.7	54.4	44	39.6	30.1	23.9		160
170					52.4	51.4	50.1	42.4	39.6	29.2	23.9		170
175					50.4	49.5	48.2	41.8	39.3	28.8	23.9		175
180					48.6	47.6	46.4	41.2	38.8	28.4	23.9		180
185						45.9	44.6	40.6	38.2	28	23.9		185
190						44.2	43	40	37.7	27.6	23.9		190
195						42.7	41.4	39.5	37.3	27.1	23.9		195
200						41.2	40	38.8	36.7	26.7	23.9		200
205							38.6	37.8	35.9	26.3	23.9		205
210							37.2	36.4	34.9	25.9	23.8		210
215							36	35.2	33.7	25.5	23.6		215
220							34.8	34	32.5	25.2	23.2		220
225							33.6	32.8	31.3	24.8	22.9		225
230								31.7	30.2	24.4	22.5		230
235								30.6	29.2	24.1	22.1		235
240								29.6	28.2	23.7	21.5		240
245								28.7	27.2	23.4	20.8		245
250									26.3	23.1	20.1		250
255									25.4	22.8	19.4		255
260									24.5	22.5	18.7		260
265									23.7	22.2	18.1		265
270									22.9	21.7	17.5		270
275									22.2	21	16.9		275
280										20.2	16.3		280
285										19.6	15.8		285
290										18.9	15.3		290
295										18.2	14.9		295
300											14.5		300
310											13.7		310
315											13.5		315
320											13.4		320

\* + 13 ft adapter

All information given are for reference only.



  
 189 ft  
 83°

  
 69-276 ft

  
 297,700 lbs

  
 32'10"x31'6"

  
 360°

**85**  
 85%

General Information

Hydraulic Truck Cranes

Crawler Cranes

Carry Decks

Rough Terrain Cranes

Rigging Equipment

Aerial Lifts

Transportation

All information given are for reference only.

ft	189*										ft
	69	92	115	138	161	184	207	230	253	276	
70	123										70
75	117	113									75
80	111	107	102								80
90	101	98	94.5	85							90
95		93.5	91	82.5							95
100		89.5	87	80	70						100
105		85.5	83.5	77.5	69	56.4					105
110		81.5	80	75.5	67	56.3					110
115		77.5	77	73.5	65	56.1	42				115
120			74	71.5	63.5	55.7	42.1	31.3			120
125			71	69	61.5	55	42.2	31.4	23.7		125
130			68	66.5	60	53.8	42.2	31.4	23.8		130
135			65	64.5	58.6	52.6	42.2	31.4	23.8	17.6	135
140				62	57	51.4	42.2	31.4	23.8	17.6	140
145				59.6	55.2	50.2	42.2	31.4	23.8	17.6	145
150				57.3	53.3	49.1	42.2	31.4	23.8	17.6	150
155				54.8	51.4	48	41.5	31.4	23.8	17.6	155
160				52.1	49.7	46.9	40.5	31.4	23.8	17.6	160
165					47.9	45.7	39.4	31.4	23.8	17.6	165
170					46.3	44.3	38.1	31.4	23.8	17.6	170
175					44.9	42.8	36.8	30.7	23.8	17.6	175
180					43.6	41.4	35.5	29.7	23.8	17.6	180
185						40.1	34.3	28.6	23.8	17.6	185
190						38.8	33.2	27.6	23.8	17.6	190
195						37.6	32.1	26.6	23	17.6	195
200						36.5	31	25.6	22.2	17.3	200
205						35.2	29.9	24.6	21.3	16.7	205
210							28.9	23.7	20.5	16	210
215							28	22.8	19.7	15.3	215
220							27.1	22	18.9	14.7	220
225							26.4	21.1	18.1	14.1	225
230								20.3	17.3	13.5	230
235								19.6	16.6	12.9	235
240								18.9	15.9	12.3	240
245								18.3	15.2	11.8	245
250								17.8	14.5	11.2	250
255								17.3	14	10.7	255
260									13.4	10.2	260
265									12.9	9.7	265
270									12.5	9.3	270
275									12.2	8.9	275
280										8.6	280
285										8.3	285
290										8	290
295										7.7	295
300										7.5	300

\* + 13 ft adapter

# 650 t All Terrain Crane

LIEBHERR LTM 1500 - 276FT



General Information



223-258 ft  
83°



69-230 ft



297,700 lbs



32'10" x 31'6"



360°

**85**

85%

Hydraulic Truck Cranes

Crawler Cranes

Carry Decks

Rough Terrain Cranes

Rigging Equipment

Aerial Lifts

Transportation

ft	223*								258*						ft
	69	92	115	138	161	184	207	230	69	92	115	138	161	184	
75	93.5														75
80	89.5	79.5							58.8						80
85	85.5	76.5							56.1						85
90	82	73	67						53.6	45.6					90
95	78.5	70.5	64.5						51.2	44.4					95
100		67.5	62	55.8						42.6	37.3				100
105		65	59.8	53.9	46.9					40.9	35.7	31.4			105
110		62.5	57.7	52.1	45.8					39.2	34.2	30			110
115		60.5	55.7	50.4	44.4	34.2				37.6	32.8	28.7			115
120			53.9	48.8	43.1	34.5	23.2			36.1	31.5	27.5	21.7		120
125			52.1	47.3	41.7	34.6	23.5				30.2	26.4	20.7	11.3	125
130			50.5	45.8	40.4	33.9	23.5				29.1	25.3	19.8	10.7	130
135			48.9	44.4	39.2	33	23.5	16			28	24.3	18.9	10.1	135
140			47.4	43.2	38.1	32.1	23.5	16			26.9	23.3	18.1	9.5	140
145				41.9	37	31.1	23.4	15.9				22.3	17.3	9	145
150				40.8	35.9	30.2	22.8	15.4				21.4	16.5	8.5	150
155				39.7	34.9	29.3	22	14.6				20.6	15.8	8	155
160				38.5	34	28.3	21	13.9				19.7	15.1	7.5	160
165					33.1	27.3	20.1	13.2				18.9	14.5	7	165
170					32.3	26.3	19.2	12.5				18.2	13.8	6.6	170
175						31.4	25.3	18.4	11.8				13.2	6.2	175
180						30.6	24.4	17.6	11.2				12.7	5.8	180
185						29.7	23.4	16.8	10.5				12.2	5.4	185
190						28.8	22.5	16.1	10				11.7	5	190
195								21.7	15.4	9.5				4.7	195
200								20.9	14.8	9				4.4	200
205								20.1	14.1	8.6				4.1	205
210									13.5	8.2				3.9	210
215									12.9	7.9				3.6	215
220									12.3	7.5					220
225									11.8	7.1					225
230									11.4	6.8					230
235									11	6.4					235
240										6.1					240
245										5.8					245
250										5.5					250
255										5.3					255

\* + 13 ft adapter

All information given are for reference only.

All information given are for reference only.

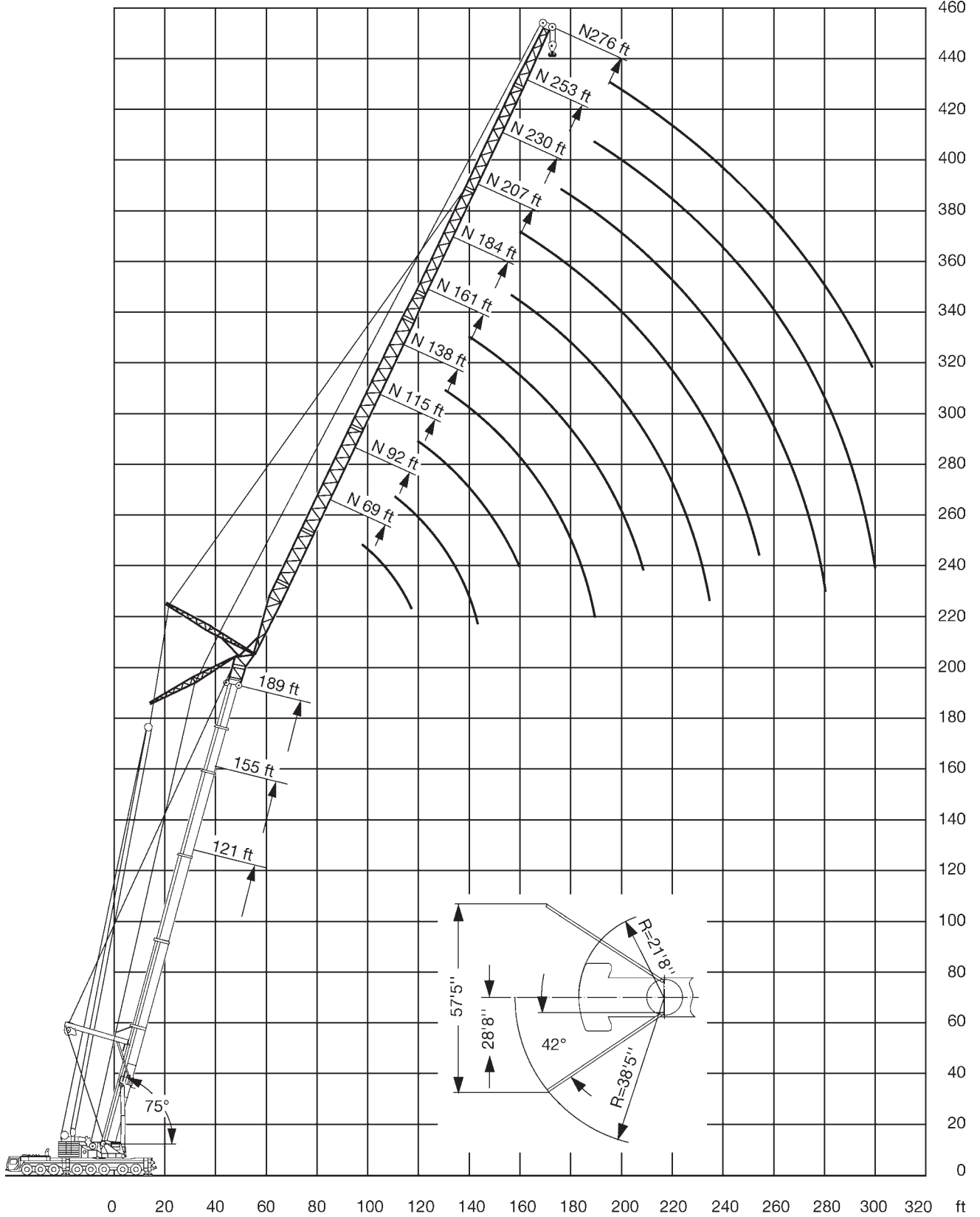

General Information  
 Hydraulic Truck Cranes  
 Crawler Cranes  
 Carry Decks  
 Rough Terrain Cranes  
 Rigging Equipment  
 Aerial Lifts  
 Transportation

# 650 t All Terrain Crane

LIEBHERR LTM 1500 - 276FT



General Information  
Hydraulic Truck Cranes  
Crawler Cranes  
Carry Decks  
Rough Terrain Cranes  
Rigging Equipment  
Aerial Lifts  
Transportation



121 ft  
75°



69-299 ft



297,700 lbs



32'10" x 31'6"



360°

**85**

85%

ft	69	92	115	138	161	121* 184	207	230	253	276	299	ft
80	125											80
90	110	108										90
100	98	96	94									100
110		86	84									110
115		81.5	80	78.5								115
120		77.5	76	74.5	73							120
125			72.5	71	69.5							125
130			69	67.5	66.5							130
135			66	64.5	63	62						135
140			63	62	60.5	59.2	57.7					140
145			60.5	59.1	57.7	56.5	55.1					145
150			57.8	56.6	55.2	54.1	52.6					150
155				54.3	52.9	51.8	50.4	49.2				155
160				52.1	50.8	49.6	48.2	47.4				160
165				50.1	48.7	47.6	46.2	45.4	43.6			165
170				48.2	46.8	45.7	44.3	43.5	41.9			170
175					45	43.9	42.6	41.8	40.2	32.1		175
180					43.3	42.2	40.9	40.1	38.5	31.5		180
185					41.7	40.6	39.3	38.5	36.9	30.9	26.9	185
190					40.2	39.1	37.8	37	35.4	30.3	26.4	190
195					38.8	37.7	36.4	35.6	34	29.7	26	195
200						36.3	35	34.2	32.7	29.2	25.6	200
205						35	33.8	32.9	31.4	28.6	25.2	205
210						33.8	32.5	31.7	30.2	28.1	24.8	210
215						32.6	31.4	30.5	29	27.6	24.4	215
220							30.3	29.4	27.9	26.7	24	220
225							29.2	28.4	26.9	25.6	23.7	225
230							28.2	27.4	25.9	24.6	23.3	230
235							27.2	26.4	24.9	23.6	22.3	235
240							26.3	25.5	24	22.7	21.4	240
245								24.6	23.1	21.9	20.6	245
250								23.7	22.2	21	19.7	250
255								22.9	21.4	20.2	18.9	255
260								22.1	20.6	19.4	18.1	260
265									19.9	18.7	17.4	265
270									19.1	17.9	16.7	270
275									18.5	17.3	16	275
280									17.8	16.6	15.3	280
285									17.1	15.9	14.7	285
290										15.3	14.1	290
295										14.7	13.5	295
300										14.2	12.9	300
305										13.6	12.4	305
310											11.9	310
320											11.2	320
325											10.8	325

\* + 13 ft adapter

All information given are for reference only.

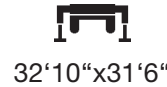

General Information

Hydraulic Truck Cranes

Crawler Cranes

Carry Decks

Rough Terrain Cranes

Rigging Equipment

Aerial Lifts

Transportation

All information given are for reference only.

ft	69	92	115	138	161	155*	184	207	230	253	276	299	ft
90	100												90
95	94												95
100	88.5	86											100
110	79.5	77											110
115		73	71.5										115
120		69.5	68	66.5									120
130		63	61.5	60									130
135		60.5	58.7	57.4	55.4								135
140			56.1	54.8	52.8								140
145			53.6	52.4	50.4	49.2							145
150			51.3	50.1	48.2	47							150
155			49.2	48	46.1	44.9	43.3						155
160				46	44.1	43	41.4						160
165				44.2	42.3	41.1	39.6	38.8					165
170				42.4	40.6	39.4	37.9	37.1					170
175				40.8	38.9	37.8	36.3	35.5					175
180				39.2	37.4	36.3	34.8	34	32.4				180
185					36	34.8	33.4	32.6	31				185
190					34.6	33.5	32	31.3	29.6				190
195					33.3	32.2	30.7	30	28.4	27			195
200					32.1	31	29.5	28.8	27.2	25.8	23.3		200
205						29.8	28.4	27.6	26	24.6	22.4		205
210						28.6	27.3	26.5	24.9	23.5	21.5		210
215						27.6	26.2	25.5	23.9	22.5	20.6		215
220						26.6	25.2	24.5	22.9	21.6	19.7		220
225						25.6	24.3	23.5	21.9	20.6	18.9		225
230							23.3	22.5	21	19.7	18.1		230
235							22.5	21.7	20.1	18.8	17.3		235
240							21.6	20.8	19.3	18	16.7		240
245							20.9	20	18.5	17.2	16		245
250								19.3	17.7	16.4	15.5		250
255								18.5	17	15.7	14.9		255
260								17.8	16.3	15	14.3		260
265								17.1	15.6	14.3	13.7		265
270								16.5	15	13.7	13.1		270
275								15.8	14.3	13.1	12.4		275
280									13.7	12.5	12		280
285									13.2	12	11.5		285
290									12.6	11.6	11.1		290
295									12.1	11.2	10.7		295
300										10.8	10.3		300
310										10	9.5		310
320										9.3	8.8		320
330											8.1		330
340											7.4		340

\* + 13 ft adapter

# 650 t All Terrain Crane

LIEBHERR LTM 1500 - 276FT



General Information



189 ft  
75°



69-276 ft



297,700 lbs



32'10" x 31'6"



360°

**85**

85%

Hydraulic Truck Cranes

Crawler Cranes

Carry Decks

Rough Terrain Cranes

Rigging Equipment

Aerial Lifts

Transportation

ft	189*										ft	
	69	92	115	138	161	184	207	230	253	276		
100	81											100
105	76.5											105
110	72.5											110
115	69	67										115
120		64										120
125		60.5	58.4									125
130		57.8	55.6									130
135		55.2	53	51.8								135
140		52.8	50.6	49.4								140
145			48.3	47.1	45.1							145
150			46.2	45.1	43.1							150
155			44.3	43.1	41.1							155
160			42.5	41.3	39.4	38.2						160
165				39.6	37.7	36.5	31.2					165
170				38	36.1	34.9	29.9					170
175				36.5	34.6	33.4	28.7					175
180				35	33.2	32	27.5	22				180
185				33.6	31.8	30.7	26.3	20.9				185
190				32.3	30.5	29.4	25.2	20				190
195					29.3	28.3	24.2	19	15.3			195
200					28.2	27.1	23.2	18.1	14.5	10.2		200
205					27.1	26	22.3	17.2	13.8	9.6		205
210						25	21.4	16.4	13	9.2		210
215						24	20.6	15.8	12.3	8.6		215
220						23.1	19.8	15.1	11.6	8.2		220
225						22.2	19	14.5	11	7.7		225
230						21.3	18.2	13.9	10.6	7.3		230
235						20.5	17.4	13.2	10.1	6.8		235
240							16.7	12.7	9.7	6.4		240
245							16	12.1	9.2	6.1		245
250							15.4	11.5	8.8	5.7		250
255							14.9	11	8.4	5.3		255
260								10.4	8	5		260
265								10	7.6	4.6		265
270								9.6	7.2	4.3		270
275								9.3	6.8	4		275
280								8.9	6.4	3.7		280
285									6.1	3.4		285
290									5.8	3		290
295									5.6	2.8		295
300									5.3	2.5		300

\* + 13 ft adapter

All information given are for reference only.

  
 223-258 ft  
 75°

  
 69-207 ft

  
 297,700 lbs

  
 32'10"x31'6"

  
 360°

**85**  
 85%

General Information

Hydraulic Truck Cranes

Crawler Cranes

Carry Decks

Rough Terrain Cranes

Rigging Equipment

Aerial Lifts

Transportation

All information given are for reference only.

ft	223*							258*					ft
	69	92	115	138	161	184	207	69	92	115	138	161	
115	61.5												115
120	59												120
125	56.6	50.8						36.5					125
130	54.1	48.9						35.2					130
135		47.1						33.8					135
140		45.3	42.1						26.3				140
145		43.7	40.5						25.3				145
150		42.2	38.9						24.3				150
155			37.4	34					23.3	19.7			155
160			36	32.7	28.8				22.4	18.8			160
165			34.7	31.3	27.7					18	14		165
170			33.4	30.2	26.5					17.1	13.3		170
175			32.1	29	25.4	17.8				16.3	12.5	7.2	175
180				28	24.4	16.9	9.6			15.5	11.9	6.8	180
185				26.9	23.5	16	9.1				11.3	6.4	185
190				25.9	22.6	15.1	8.6				10.9	6	190
195				24.9	21.7	14.4	8.1				10.4	5.6	195
200					20.8	13.7	7.7				9.9	5.2	200
205					20	13.1	7.2				9.5	4.9	205
210					19.2	12.6	6.8					4.5	210
215					18.4	12	6.4					4.2	215
220					17.7	11.5	6					3.9	220
225						10.9	5.6					3.6	225
230						10.4	5.2						230
235						9.9	4.9						235
240						9.5	4.6						240
245							4.2						245
250							3.9						250
255							3.5						255
260							3.3						260
265							3						265

\* + 13 ft adapter

# 650 t All Terrain Crane

LIEBHERR LTM 1500 - 276FT



- General Information
- Hydraulic Truck Cranes**
- Crawler Cranes
- Carry Decks
- Rough Terrain Cranes
- Rigging Equipment
- Aerial Lifts
- Transportation

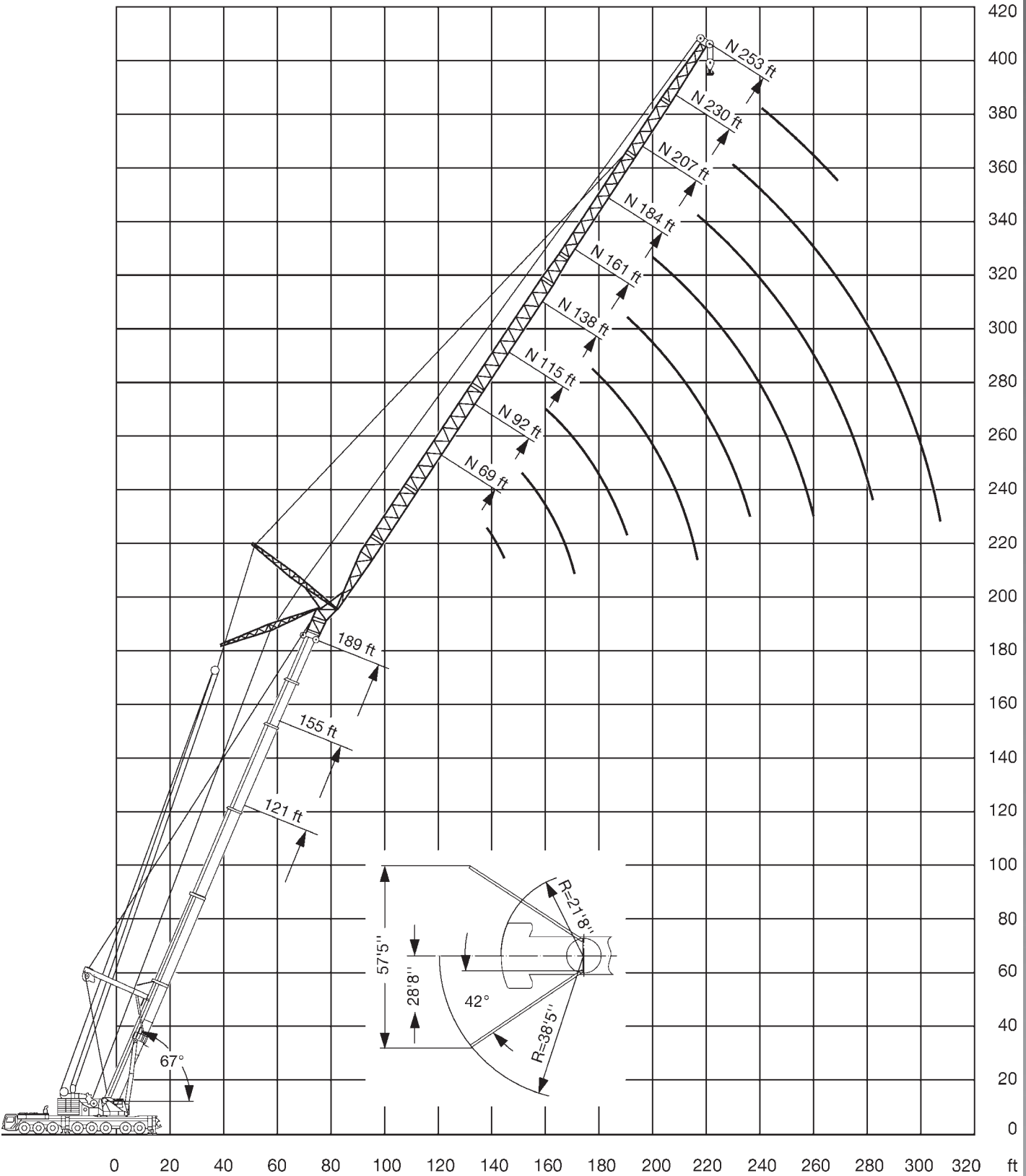

All information given are for reference only.





General Information

All information given are for reference only.

ft	69	92	115	138	161	121* 184	207	230	253	276	299	ft
105	80											105
110	75.5											110
115	72											115
120		66										120
125		63										125
130		60										130
135		57.4	55.6									135
140		54.8	53.1									140
145			50.7	49.4								145
150			48.6	47.2								150
155			46.6	45.2								155
160			44.7	43.4	41.9							160
165				41.6	40.1							165
170				39.9	38.4							170
175				38.3	36.9	35.6						175
180				36.9	35.4	34.2						180
185				35.5	34	32.8	31.3					185
190				34.1	32.7	31.5	30					190
195					31.4	30.3	28.8					195
200					30.2	29.1	27.6	26.8				200
205					29.1	27.9	26.5	25.7				205
210						26.9	25.5	24.6	23			210
215						25.8	24.5	23.6	22			215
220						24.9	23.5	22.7	21.1			220
225						23.9	22.6	21.7	20.2	18.8		225
230						23	21.7	20.8	19.3	18		230
235						22.2	20.9	20	18.5	17.1		235
240							20.1	19.2	17.7	16.4	15	240
245							19.3	18.4	16.9	15.6	14.2	245
250							18.6	17.7	16.2	14.9	13.5	250
255							17.9	17	15.5	14.2	12.8	255
260								16.3	14.8	13.5	12.2	260
265								15.7	14.1	12.9	11.7	265
270								15	13.5	12.3	11.2	270
275								14.4	12.9	11.8	10.8	275
280								13.8	12.4	11.4	10.3	280
285									11.9	10.9	9.9	285
290									11.5	10.5	9.5	290
295									11.1	10.1	9.1	295
300									10.7	9.7	8.7	300
305										9.4	8.4	305
310										9	8	310
320										8.3	7.3	320
325										8	7	325
330											6.7	330
340											6.1	340

Hydraulic Truck Cranes

Crawler Cranes

Carry Decks

Rough Terrain Cranes

Rigging Equipment

Aerial Lifts

Transportation

\* + 13 ft adapter

# 650 t All Terrain Crane

LIEBHERR LTM 1500 - 276FT



General Information



155 ft  
67°



69-299 ft



297,700 lbs



32'10"x31'6"



360°

**85**

85%

Hydraulic Truck Cranes

Crawler Cranes

Carry Decks

Rough Terrain Cranes

Rigging Equipment

Aerial Lifts

Transportation

ft	69	92	115	138	161	155*	184	207	230	253	276	299	ft
120	58												120
125	55.2												125
130	52.6												130
135		48											135
140		45.8											140
145		43.7	41.9										145
150		41.8	40.1										150
155		40.1	38.3										155
160			36.7	35.4									160
165			35.1	33.8									165
170			33.6	32.3									170
175			32.3	31	29								175
180				29.7	27.7								180
185				28.5	26.5	25.2							185
190				27.3	25.3	24.1							190
195				26.2	24.3	23							195
200				25.1	23.3	22	20.5						200
205					22.3	21.1	19.5						205
210					21.3	20.2	18.6						210
215					20.5	19.3	17.8						215
220					19.7	18.4	16.9	16.1					220
225						17.7	16.2	15.3					225
230						16.9	15.4	14.6	13				230
235						16.2	14.7	13.9	12.3				235
240						15.5	14	13.2	11.7				240
245						14.8	13.4	12.6	11.3	10.2			245
250							12.8	12	10.8	9.7			250
255							12.2	11.6	10.3	9.3			255
260							11.8	11.1	9.9	8.9	8.2		260
265							11.4	10.7	9.5	8.4	7.7		265
270								10.3	9.1	8	7.3		270
275								9.9	8.7	7.6	6.8		275
280								9.5	8.3	7.2	6.4		280
285								9.1	7.9	6.8	6		285
290								8.8	7.6	6.4	5.5		290
295								8.4	7.2	6	5.1		295
300									6.9	5.7	4.8		300
305									6.6	5.3	4.4		305
310									6.3	4.9	4		310
315										4.6	3.7		315
320										4.3	3.3		320
325										4	3		325
330										3.7			330
340										3.1			340

\* + 13 ft adapter

All information given are for reference only.

 189 ft  
67°

69-253 ft



297,700 lbs



32'10"x31'6"



360°

**85**

85%

General Information

Hydraulic Truck Cranes

Crawler Cranes

Carry Decks

Rough Terrain Cranes

Rigging Equipment

Aerial Lifts

Transportation

All information given are for reference only.

ft	69	92	115	138	189*	184	207	230	253	ft
140	41				161					140
155		34.1								155
160		32.6								160
165		31.1	28.9							165
170		29.8	27.6							170
175			26.4							175
180			25.3	24.1						180
185			24.2	23						185
190			23.2	22						190
195				21	19					195
200				20.1	18.1					200
205				19.2	17.3	16.1				205
210				18.4	16.5	15.3				210
215				17.6	15.7	14.5				215
220					15	13.8	12.2			220
225					14.3	13.1	11.7			225
230					13.6	12.4	11.2	7.9		230
235					13	11.9	10.7	7.5		235
240						11.5	10.3	7		240
245						11	9.8	6.6	4.1	245
250						10.6	9.4	6.3	3.7	250
255						10.2	9	5.9	3.4	255
260						9.8	8.7	5.5	3.1	260
265							8.3	5.1	2.8	265
270							7.9	4.8	2.4	270
275							7.5	4.5	2.2	275
280							7.1	4.1		280
285								3.8		285
290								3.5		290
295								3.3		295
300								3		300
305								2.7		305





\* + 13 ft adapter

# 650 t All Terrain Crane

LIEBHERR LTM 1500 - 276FT



General Information  
Hydraulic Truck Cranes  
Crawler Cranes  
Carry Decks  
Rough Terrain Cranes  
Rigging Equipment  
Aerial Lifts  
Transportation

					<b>85</b>
223-258 ft 67°	69-184 ft	297,700 lbs	32'10"x31'6"	360°	85%

ft	223*						258*			ft
	69	92	115	138	161	184	69	92	115	
155	29.7									155
165		25.4								165
170		24.2								170
175		23.2					20.1			175
180		22.1								180
185			19					12.5		185
190			18.1					12		190
195			17.2					11.5		195
200			16.4	15.3					6.7	200
205				14.5					6.4	205
210				13.8	10.7				6	210
215				13.1	10.3				5.7	215
220				12.5	9.8				5.5	220
225				12	9.4	4.1				225
230					9	3.8				230
235					8.6	3.4				235
240					8.2	3.1				240
245					7.9	2.8				245
250						2.6				250
255						2.3				255

\* + 13 ft adapter

All information given are for reference only.